

12" Ridge

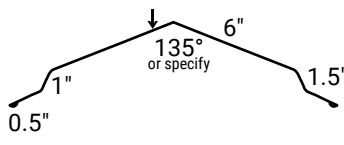

16" Ridge

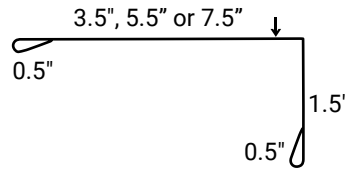

Fascia/Eave (1.5 x 3.5, 5.5 or 7.5)

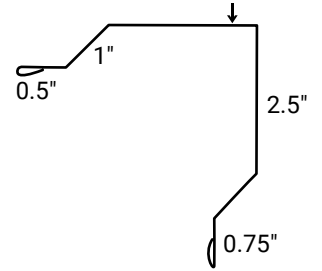

SM Outside Corner

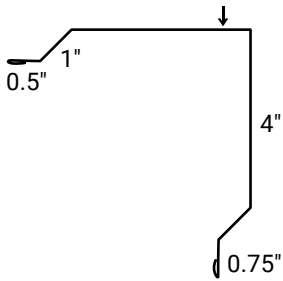

LG Outside Corner

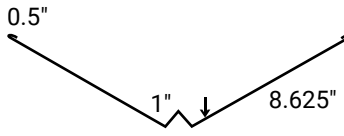

W-Valley

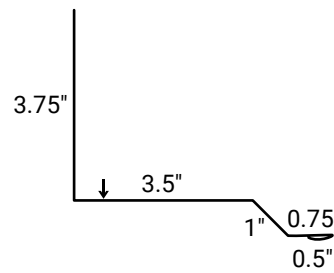

Sidewall

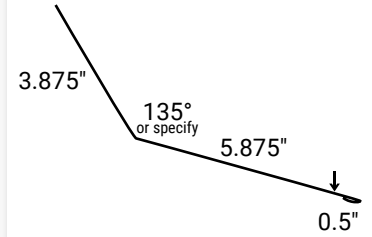

Endwall/Pitch Break

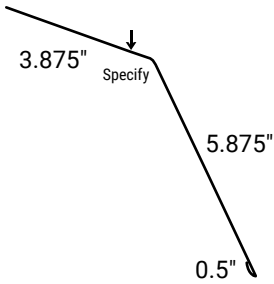

Gambrel

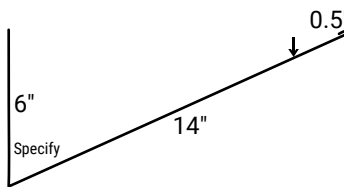

Upper Chimney

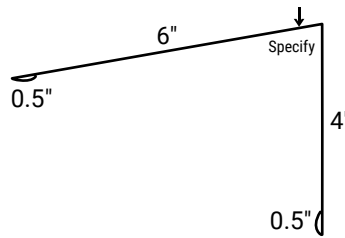

High Side Peak

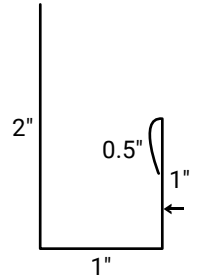

J-Channel

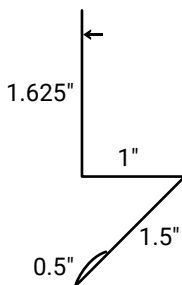

Rat Guard

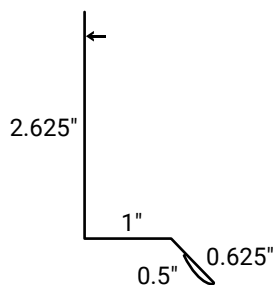

Drip Cap

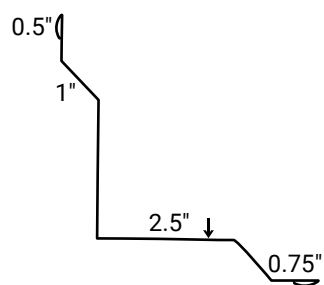

SM Inside Corner

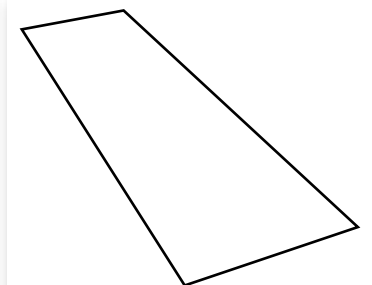

Flat Sheet

Arrow indicates finish side.
Nominal 1/2" hems unless otherwise noted.
Standard trim length is 10'. Longer lengths available.
Custom trim is available in nearly any shape, size, or angle.

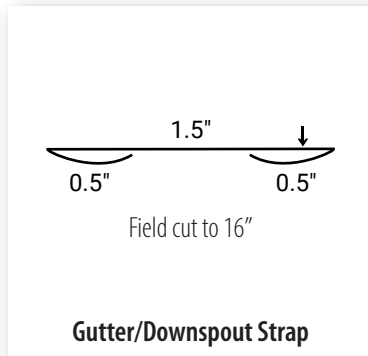
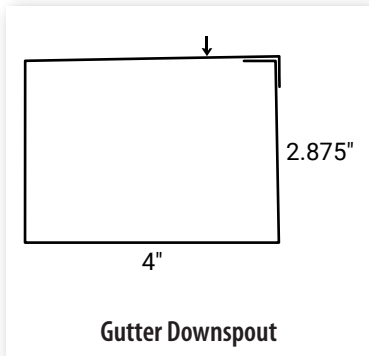
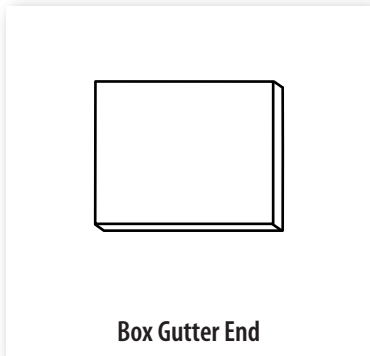
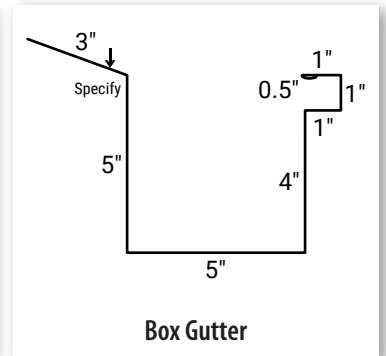
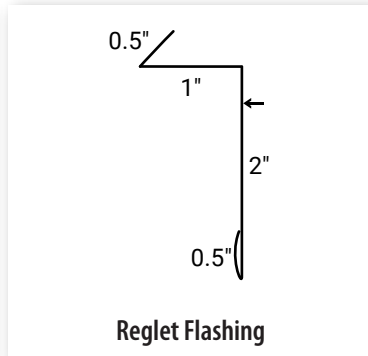
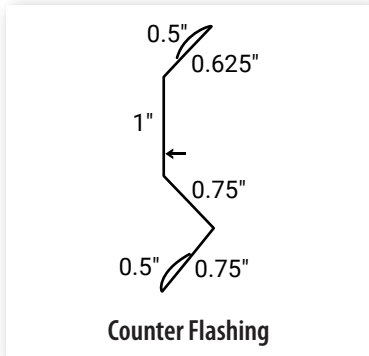
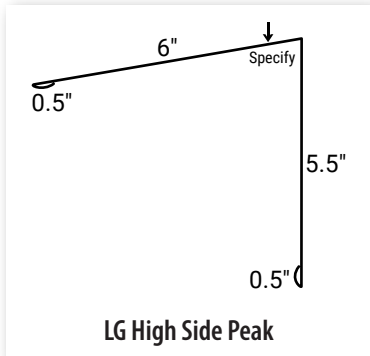
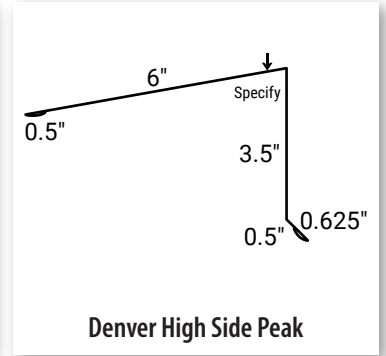
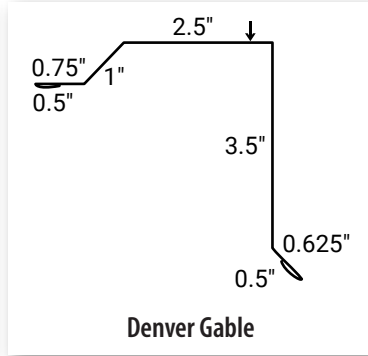
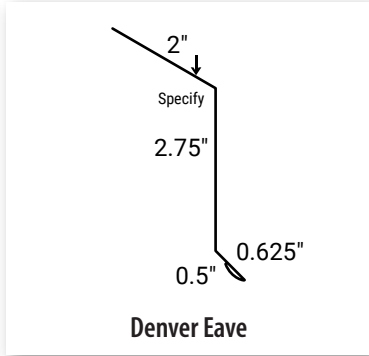
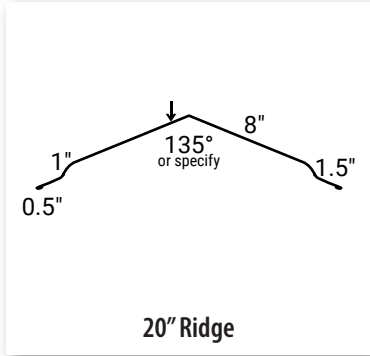
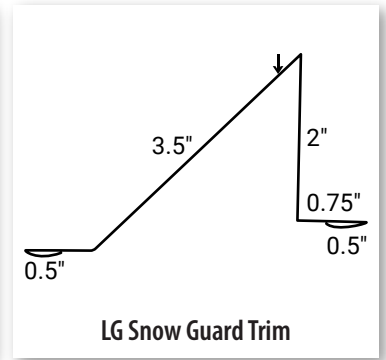
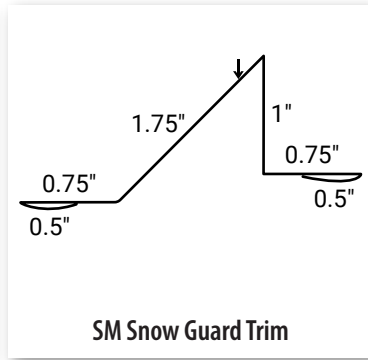
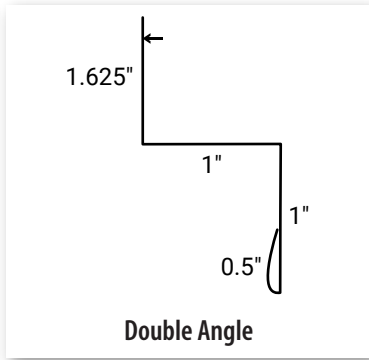
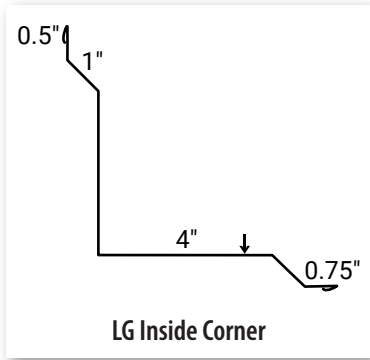

Arrow indicates finish side.
Nominal 1/2" hems unless otherwise noted.
Standard trim length is 10'. Longer lengths available.
Custom trim is available in nearly any shape, size, or angle.